

FAILURE TO FOLLOW THESE INSTRUCTIONS COULD RESULT IN DAMAGE
TO THE PRODUCT AND VOID THE FACTORY WARRANTY



Preparing to Install

#2 Phillips Screwdriver

2-3/8" through bolt posts

2-3/4" through bolt posts
Note: Adjustment based on backset



Determining Lever Handing Left Hand Options



The hand of a door is determined from the secure side of the door. The term "secure" means the side from which you initially unlock and enter.

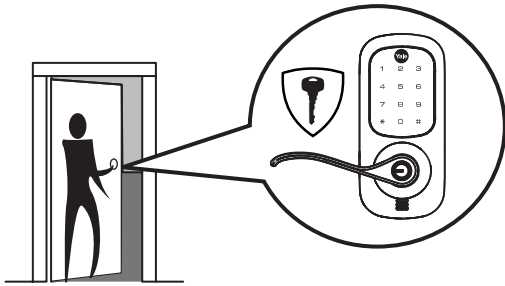

Left Hand
Hinges Left.
Open Inward.
"LH"

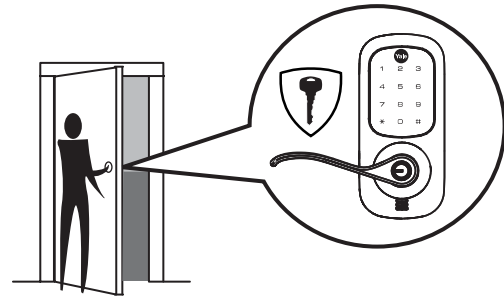

Left Hand Reverse
Hinges Left.
Open Outward
"LHR"

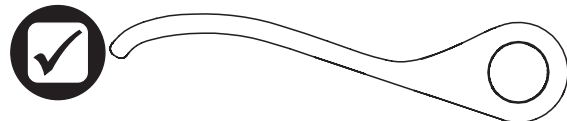
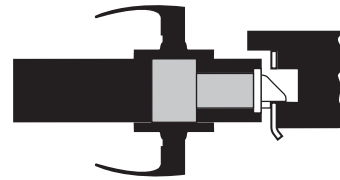
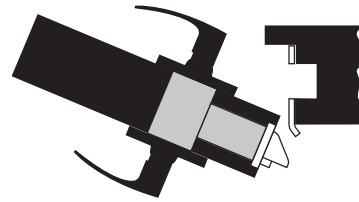
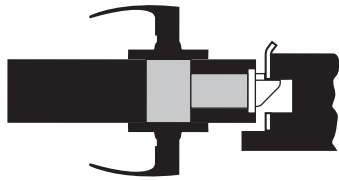
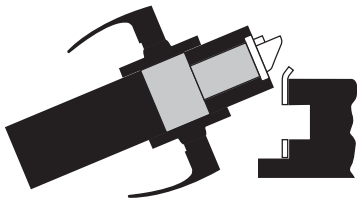



Determining Lever Handing Right Hand Options



The hand of a door is determined from the secure side of the door. The term "secure" means the side from which you initially unlock and enter.

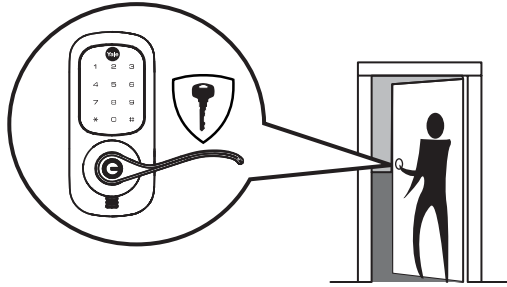

Right Hand
Hinges Right.
Open Inward.
"RH"

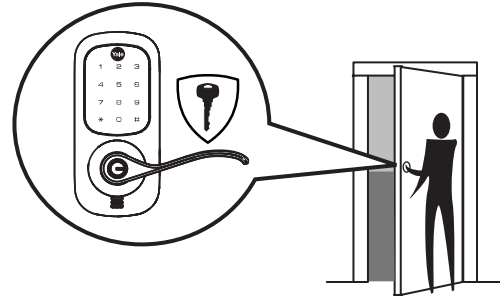
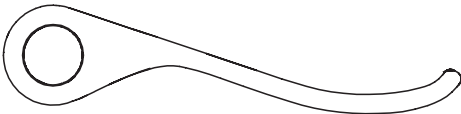
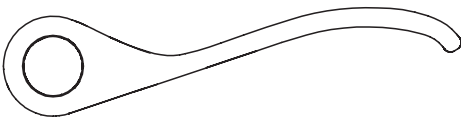
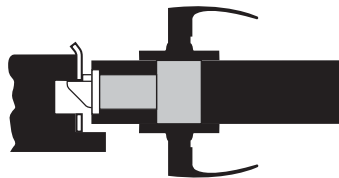
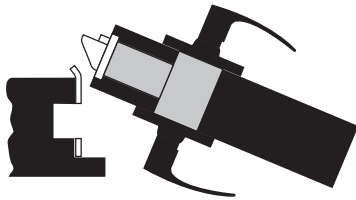

Right Hand Reverse
Hinges Right.
Open Outward
"RHR"

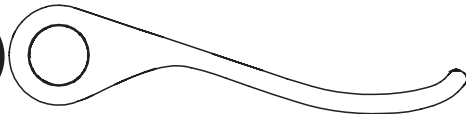
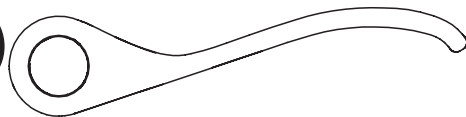
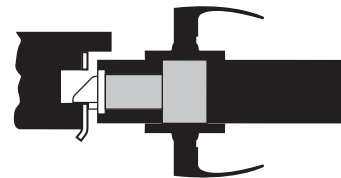
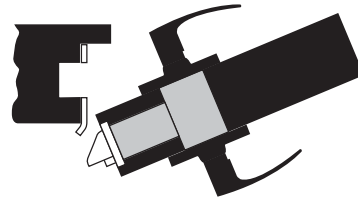

1

Installing Latch & Strike Plate Left Hand Installation Shown



x4

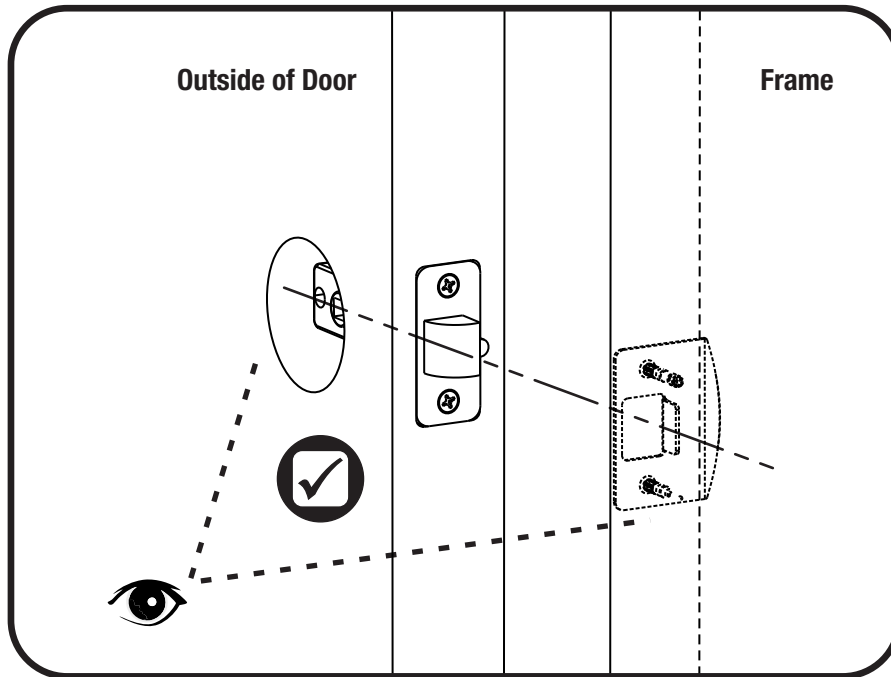
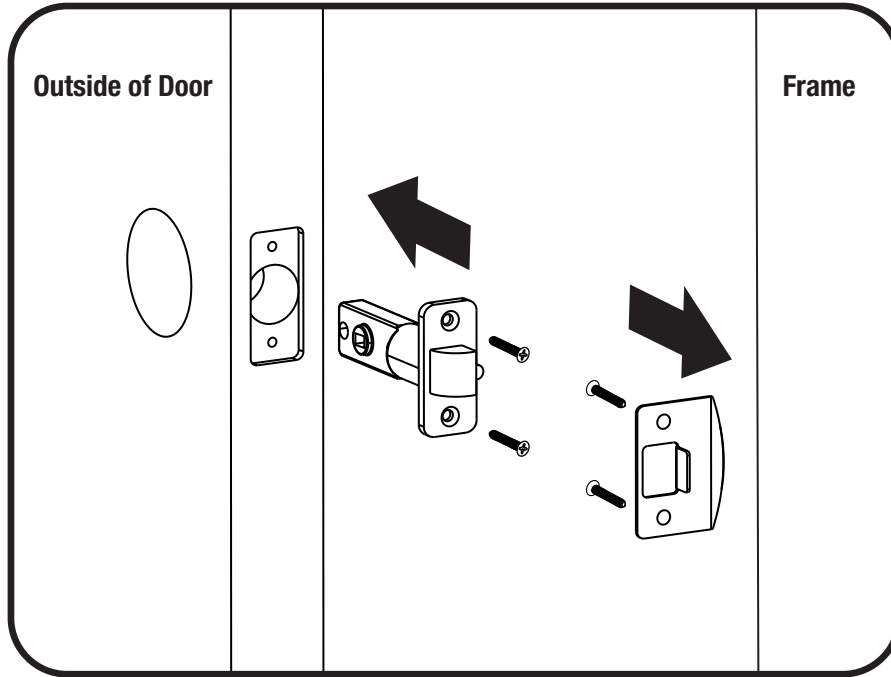

2

Installing Exterior Escutcheon Left Hand Installation Shown

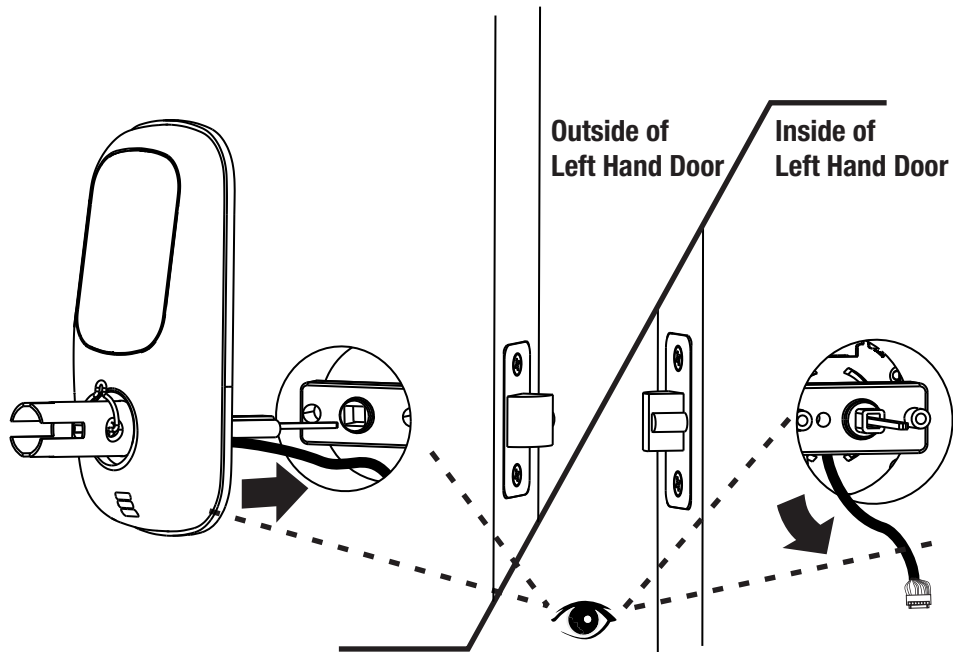
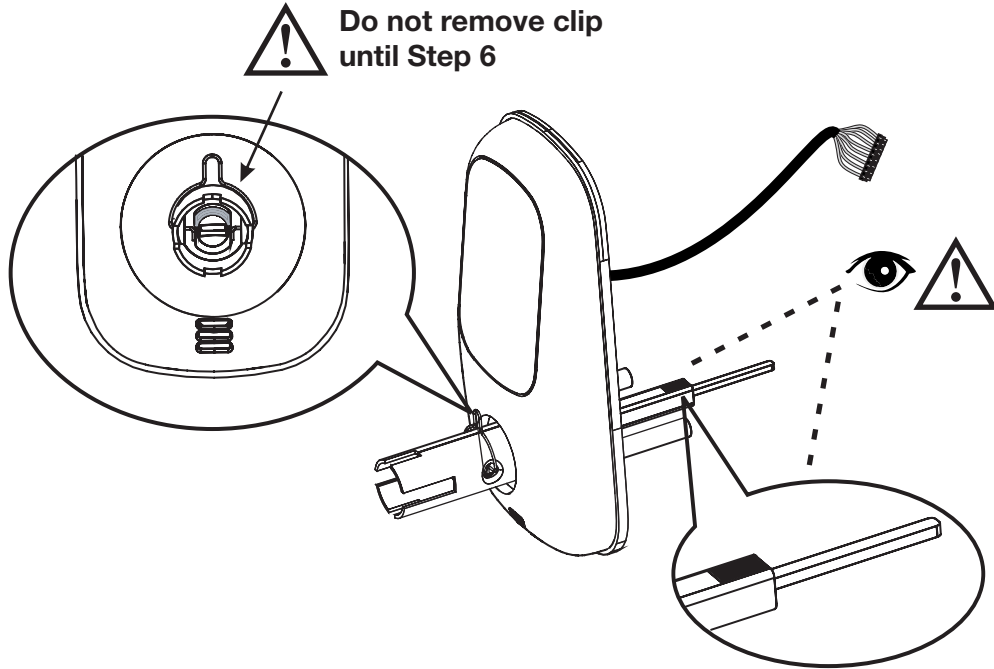

3

Installing Interior Mounting Plate Left Hand Installation Shown



x2

Loosen screw to
remove cover.

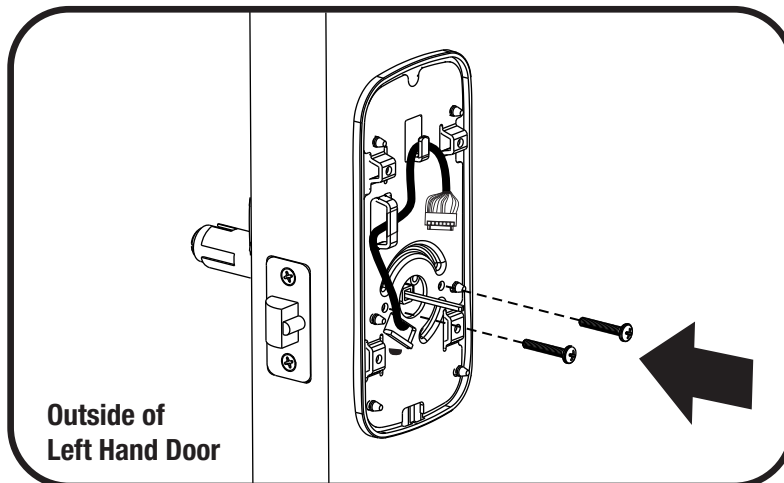
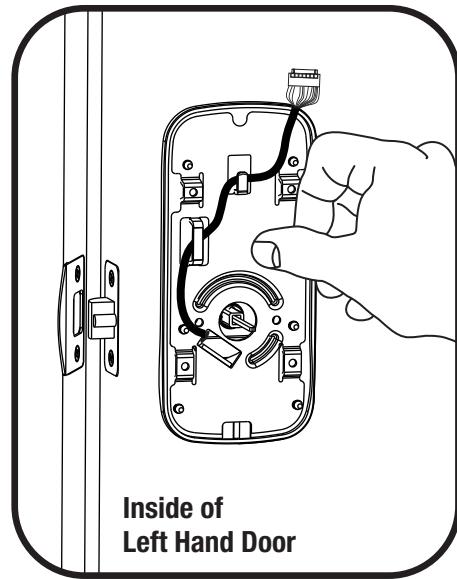
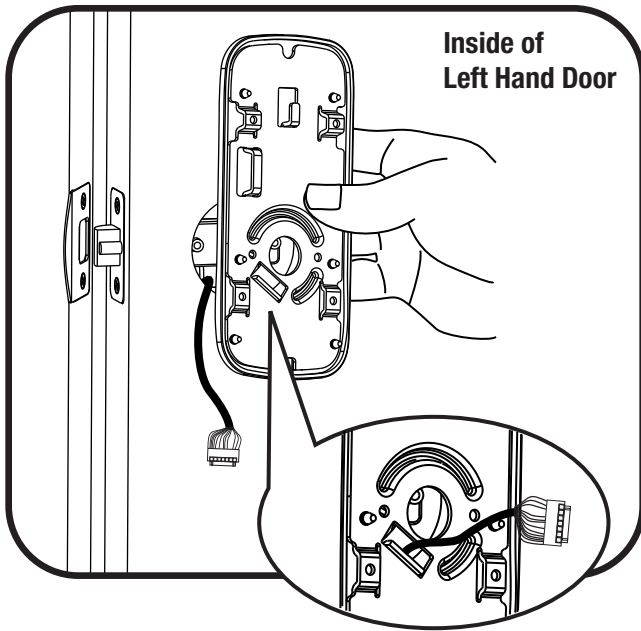
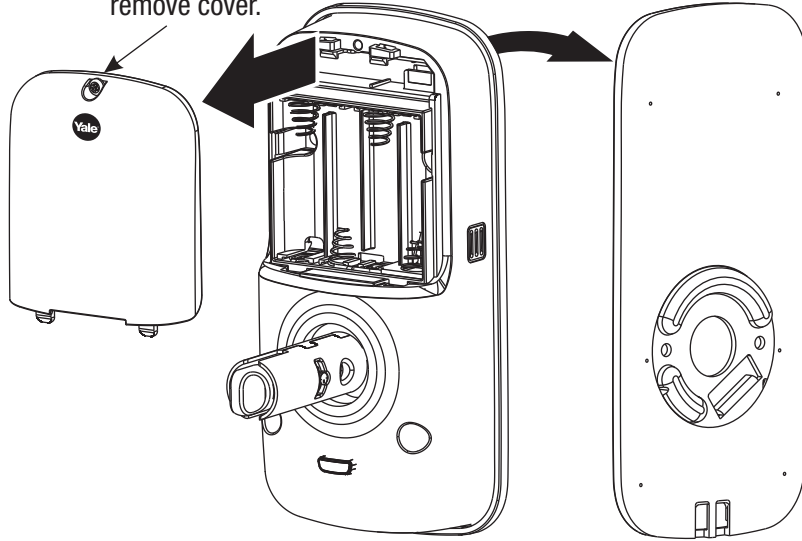

4

Attaching the Cable Assembly Left Hand Installation Shown

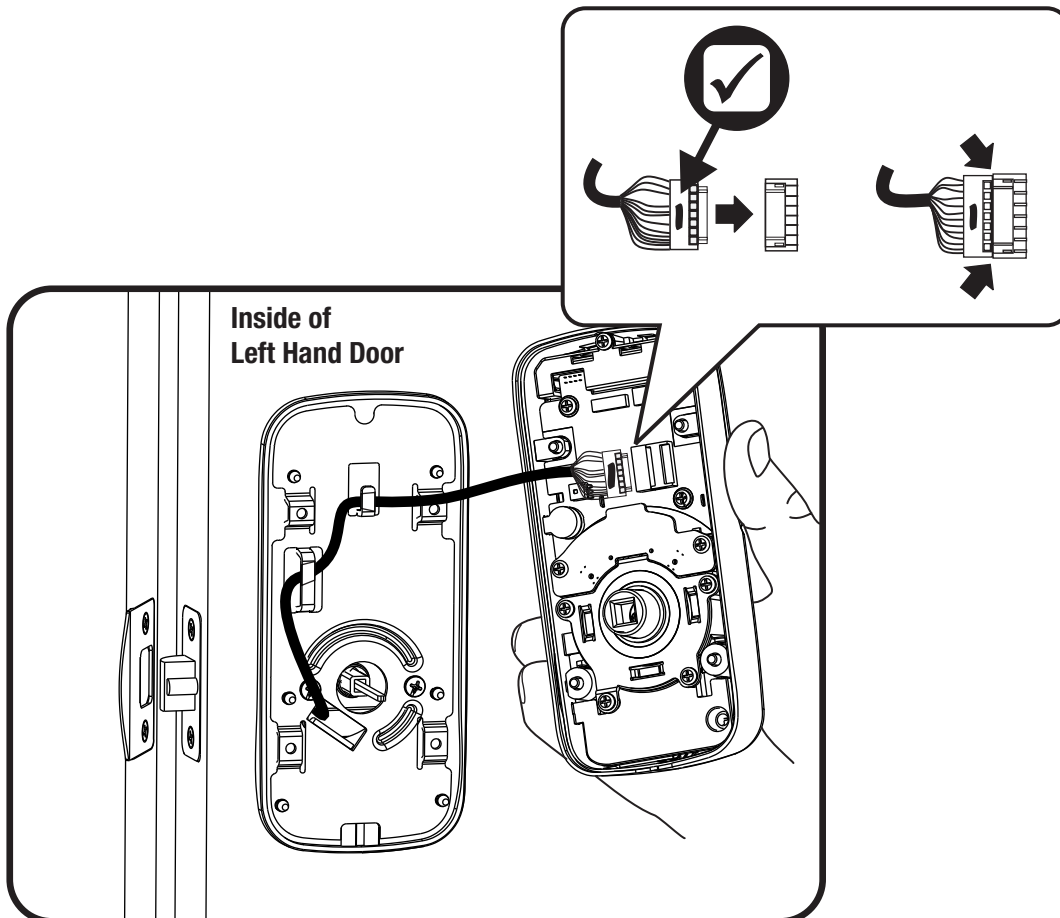
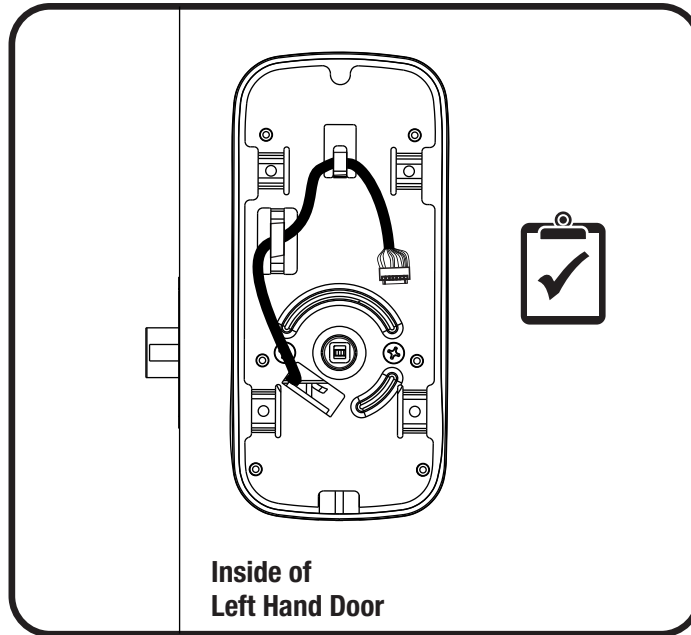

5

Installing Interior Escutcheon Left Hand Installation Shown



x4

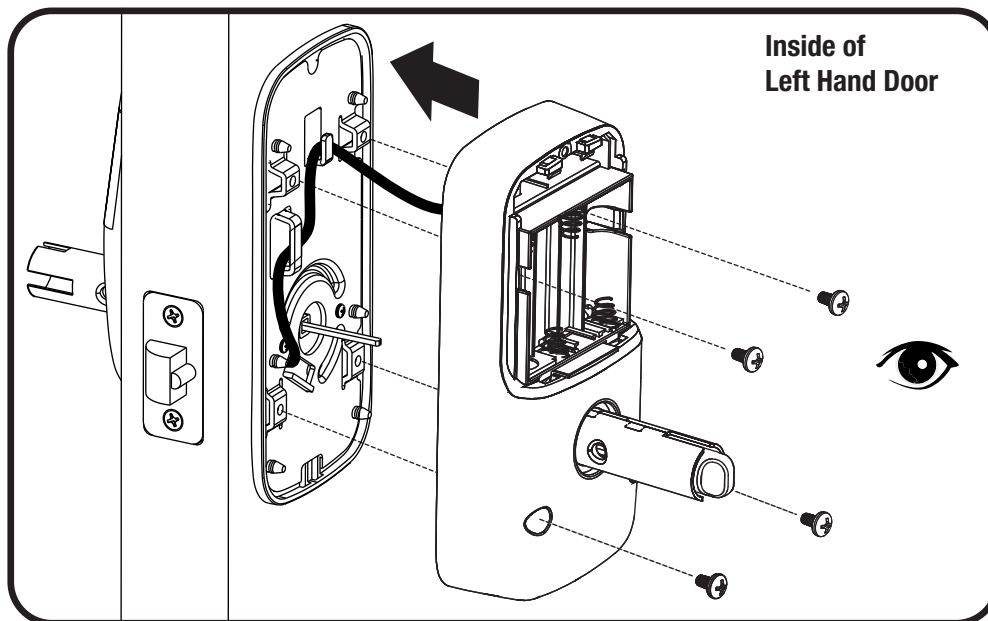
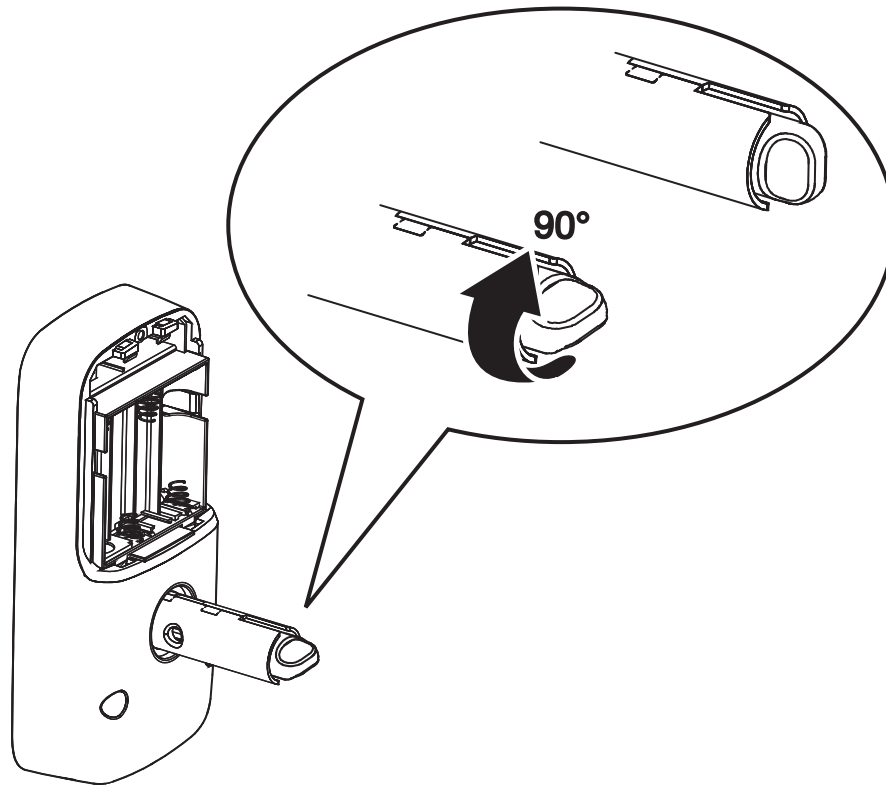

6

Installing Exterior Lever

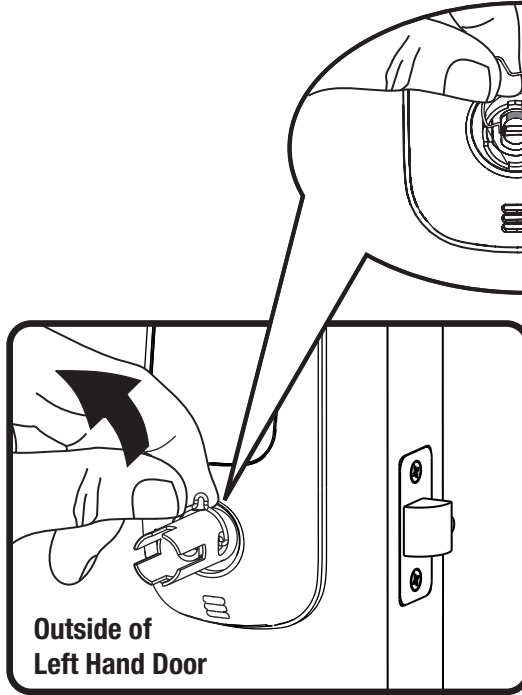
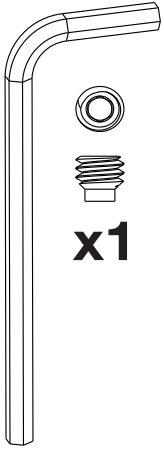

Remove clip.
Do not rotate internal cam (marked red). Red mark must remain on top and in position.

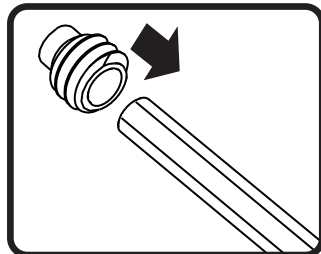

6

Installing Exterior Lever con't

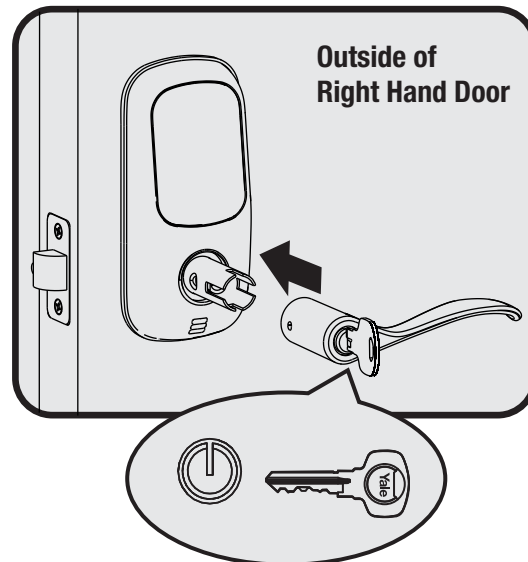
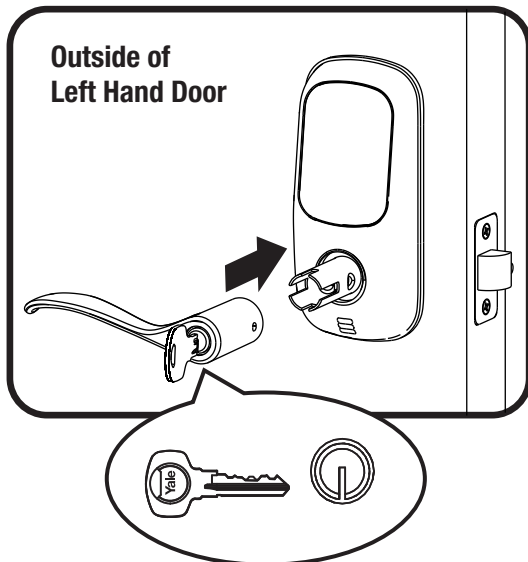
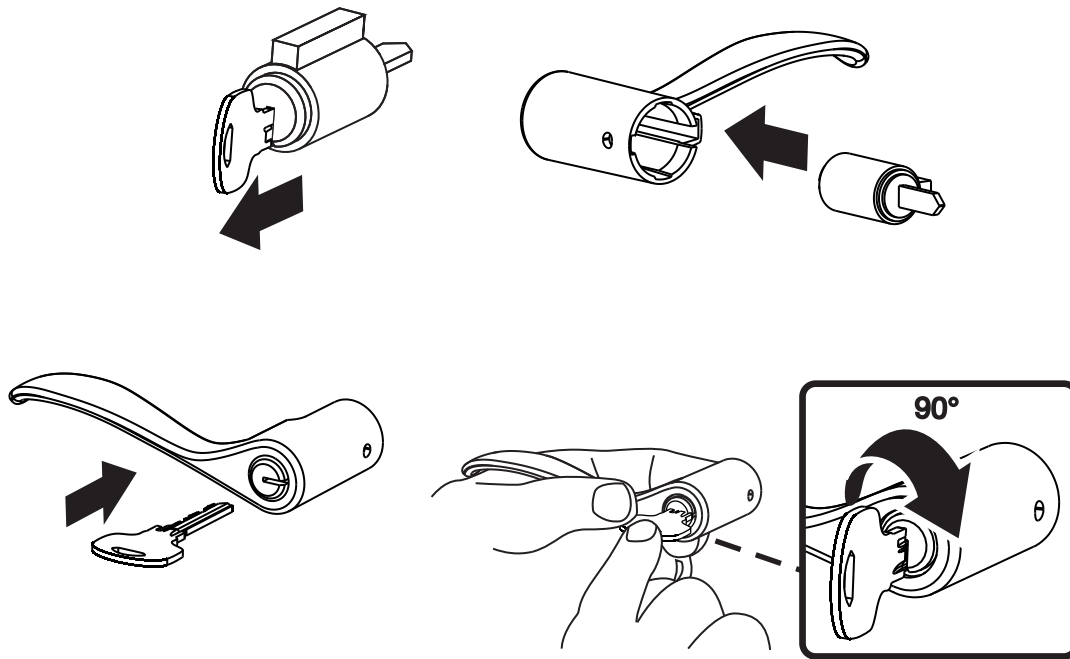

6

Installing Exterior Lever con't

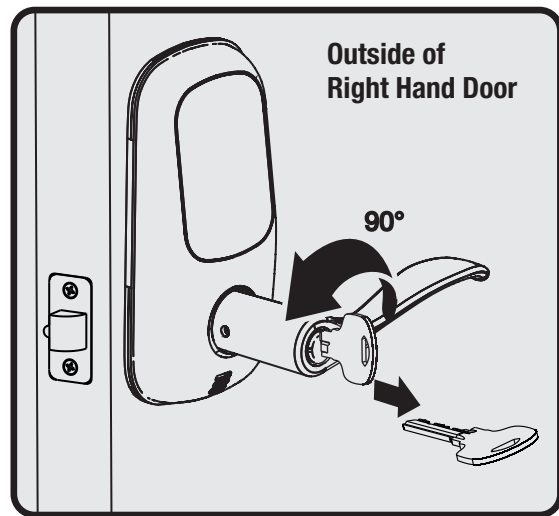
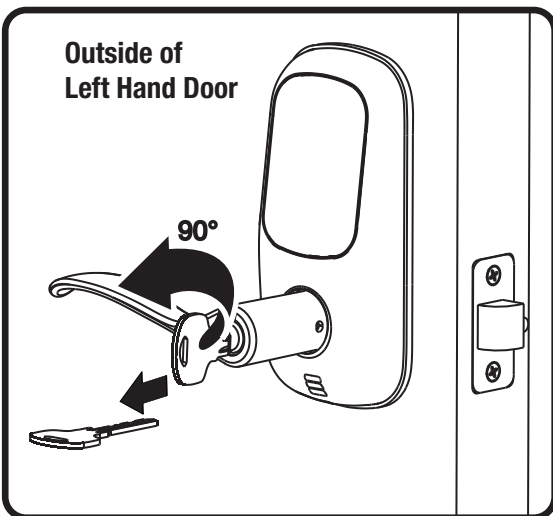
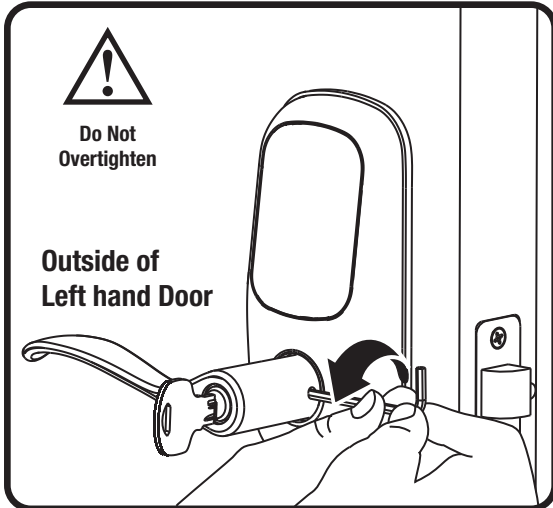



Testing Operation



Left Hand Door Shown

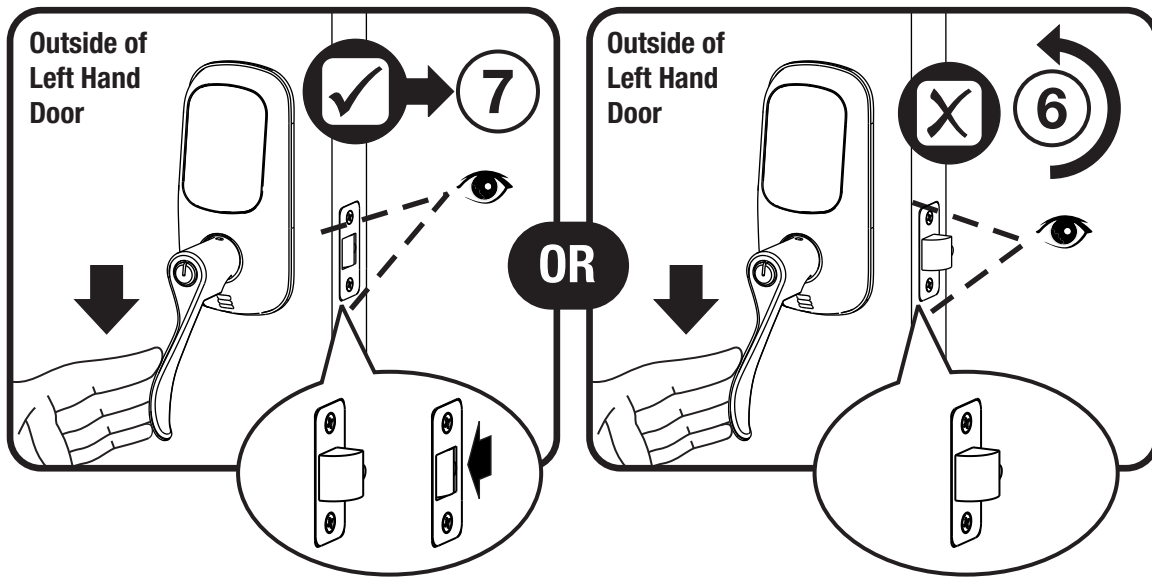

Right Hand Door Shown

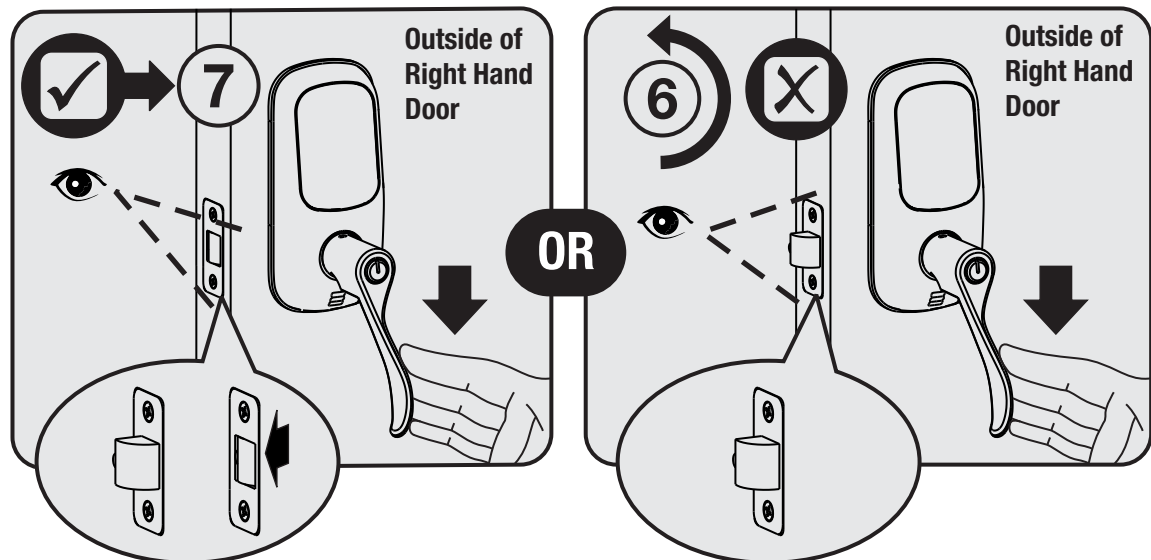

7

Installing Interior Lever

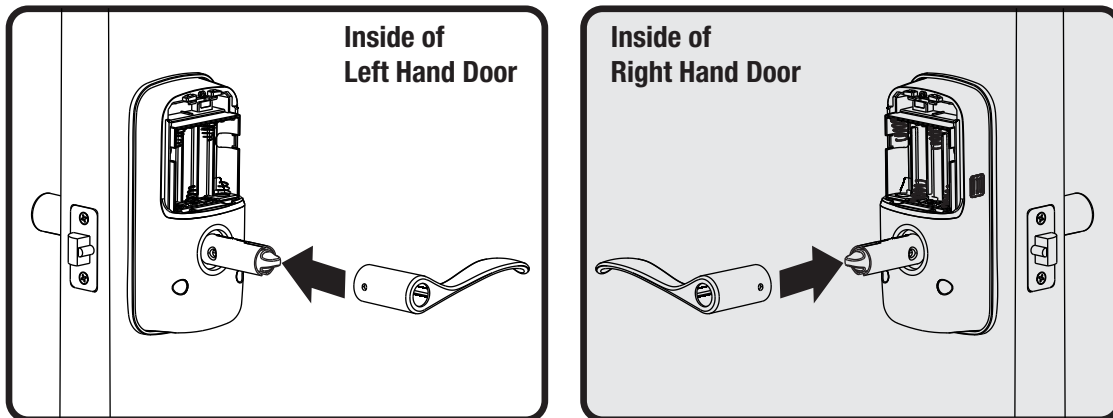
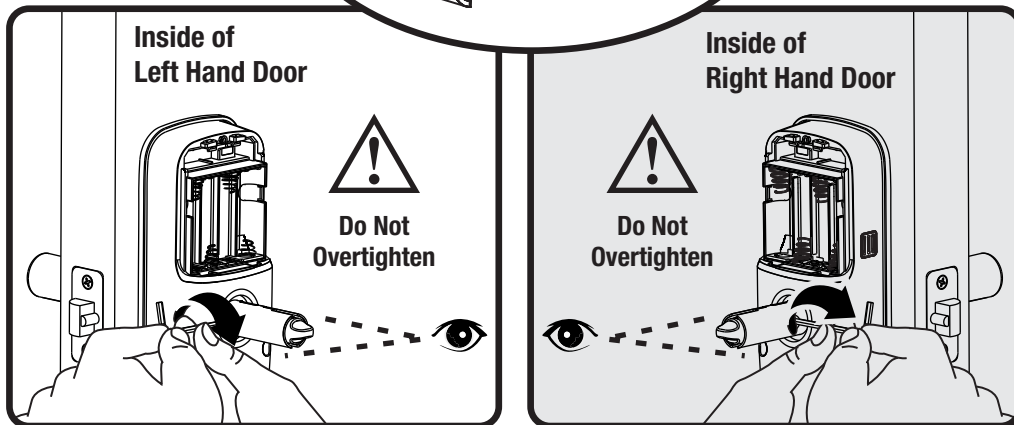
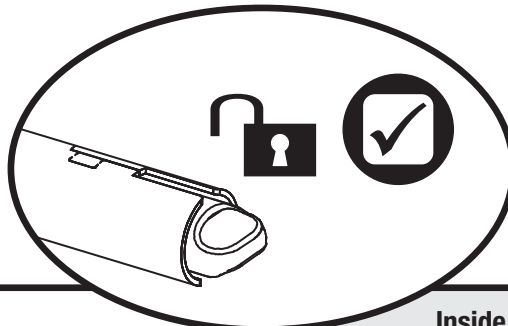
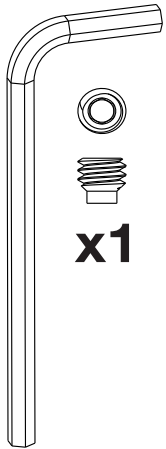

Almost done! Turn sheet over to finish installation and customize your product with Programming Instructions.

7

Installing Interior Lever con't

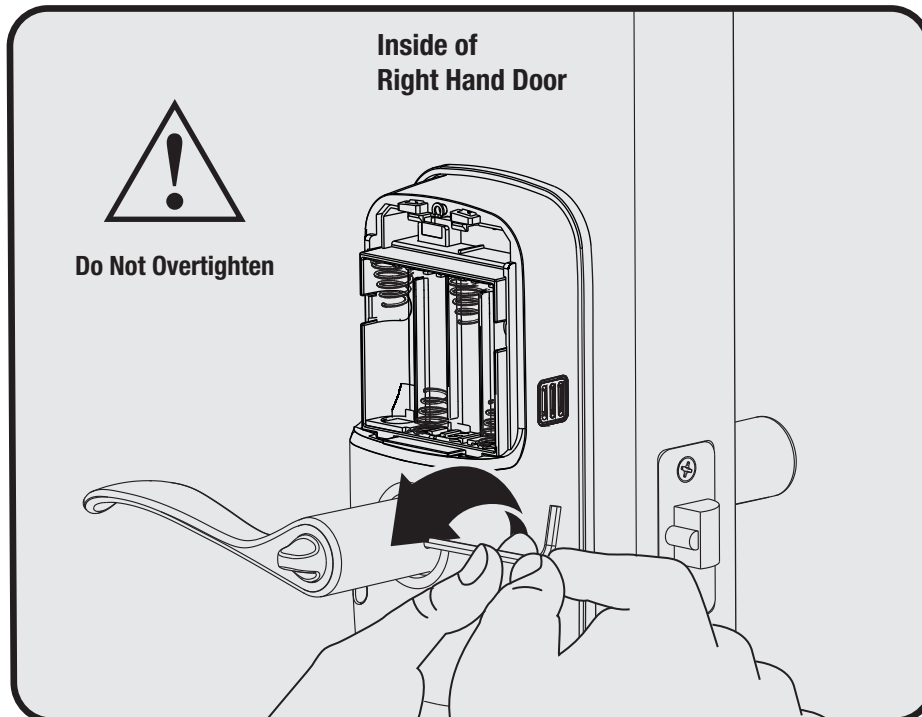
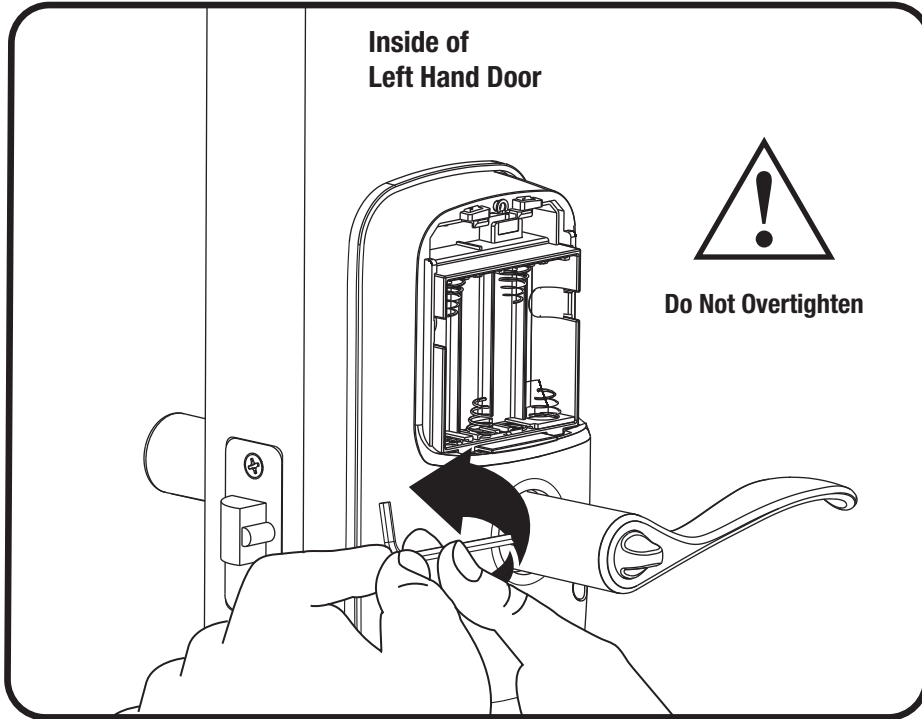



Testing Final Operation

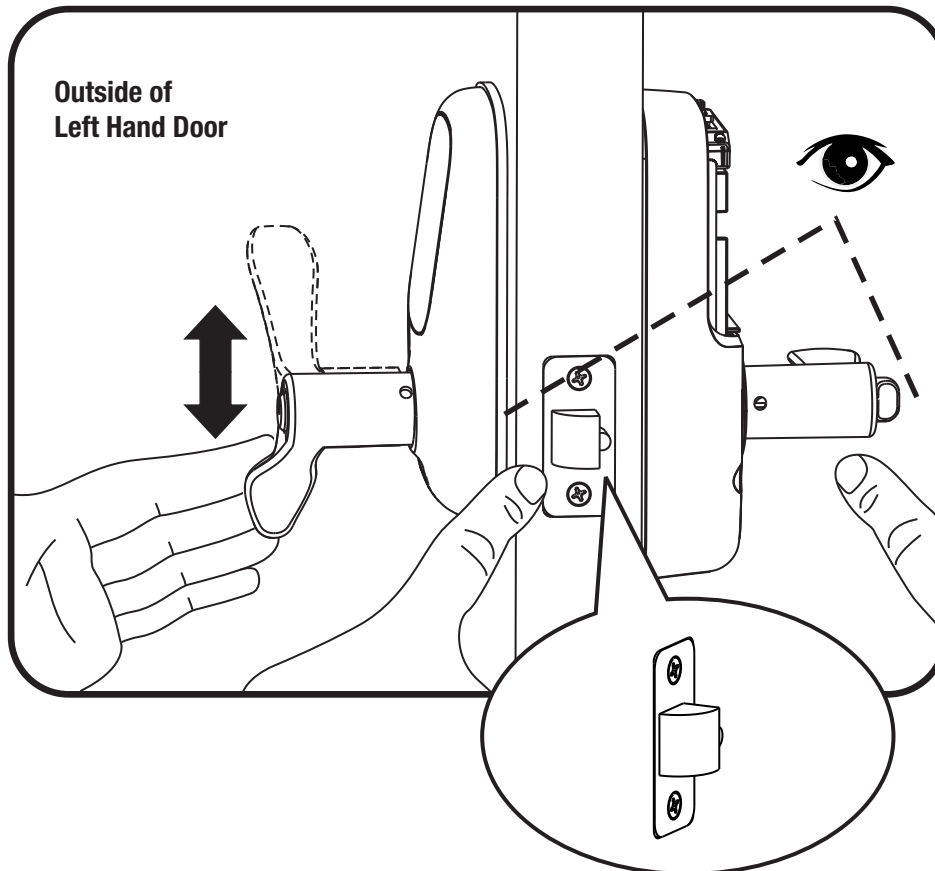
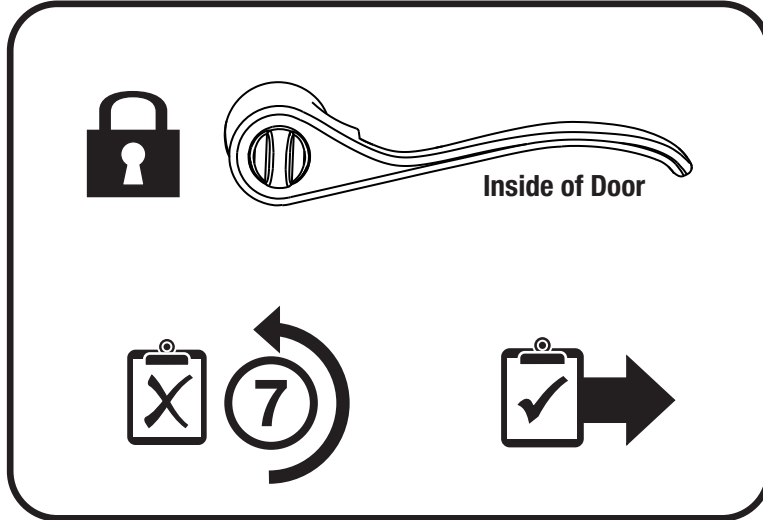



Testing Final Operation

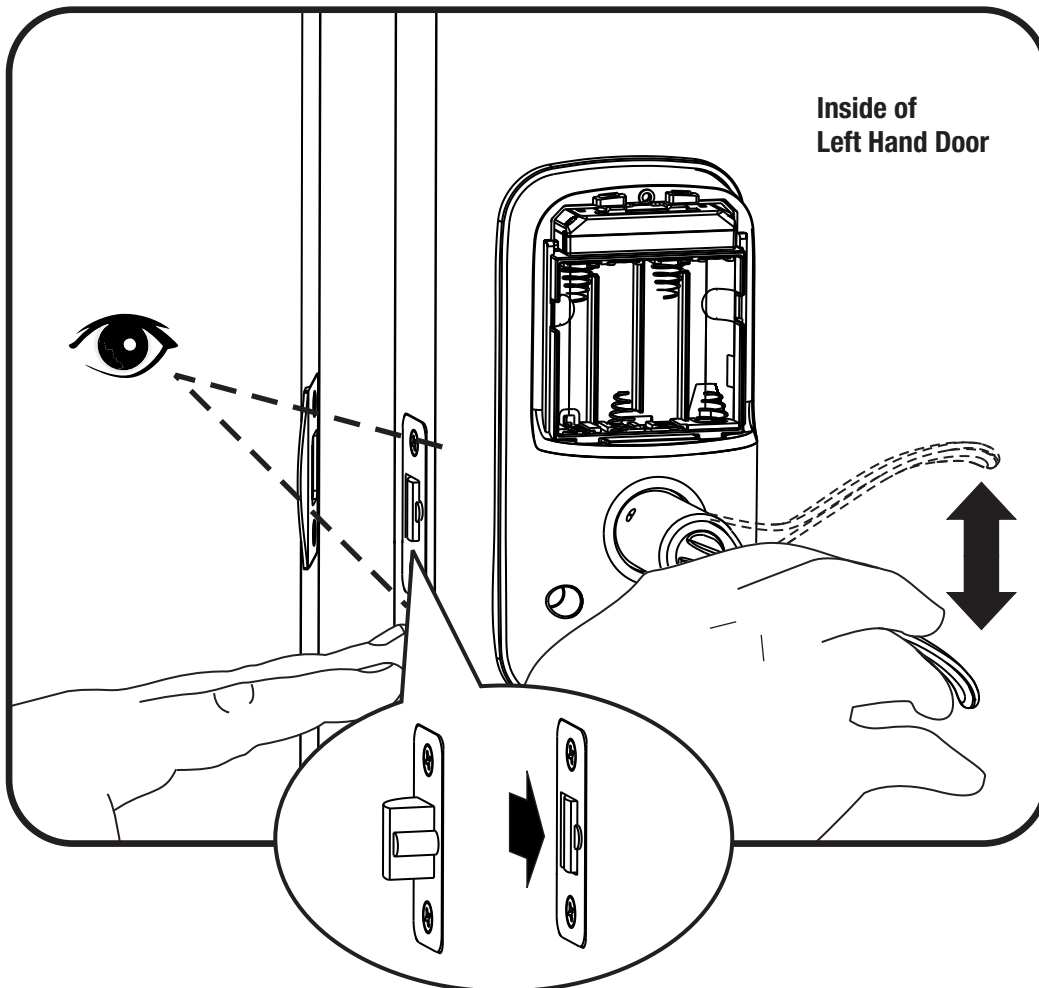
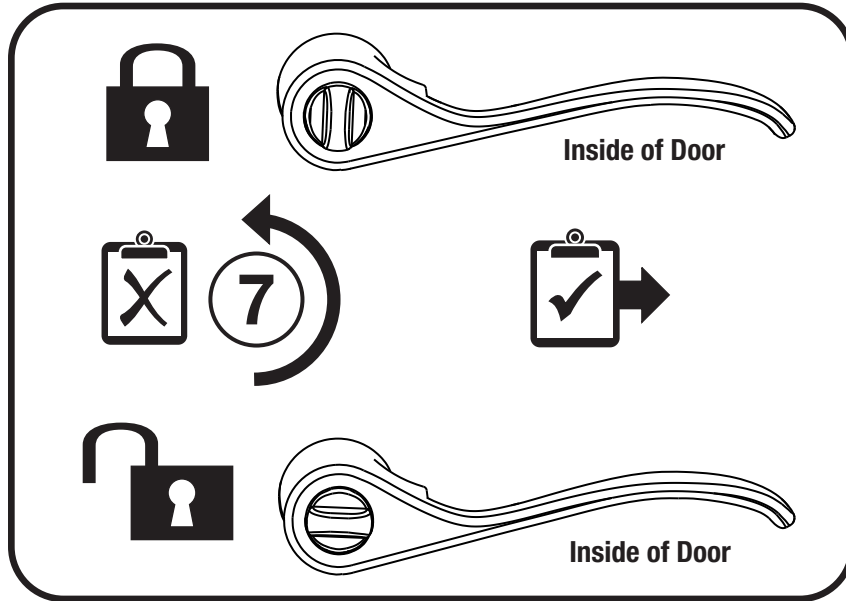



Testing Final Operation

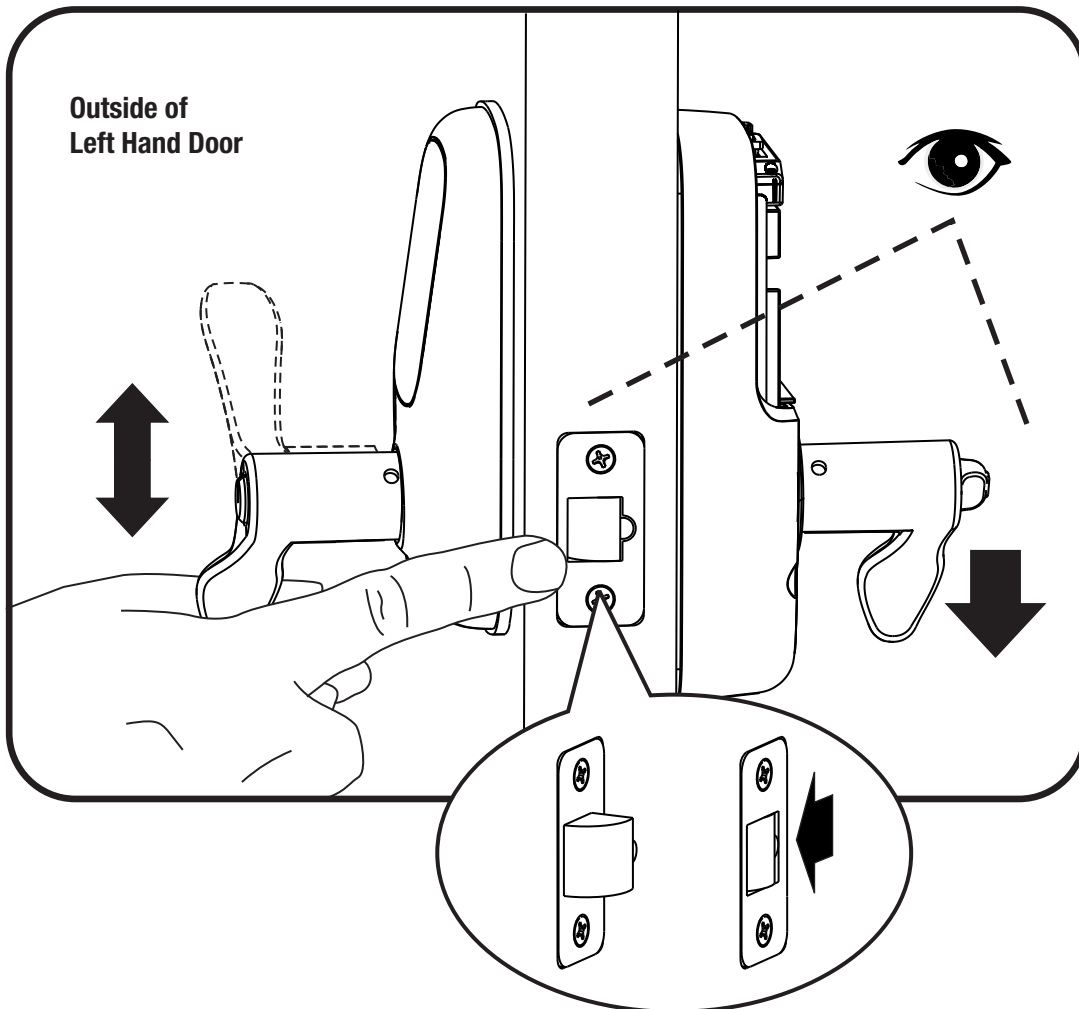
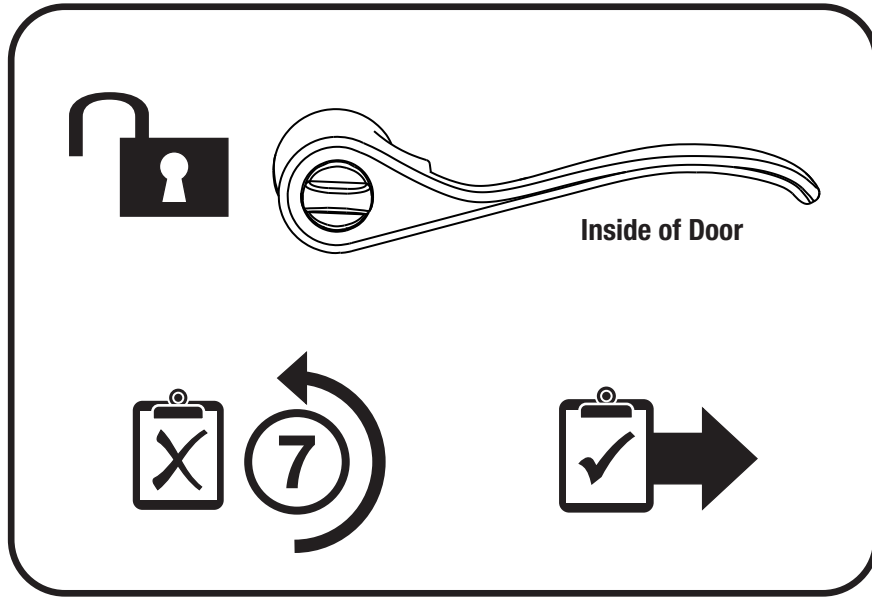

8

Installing Optional Radio Module

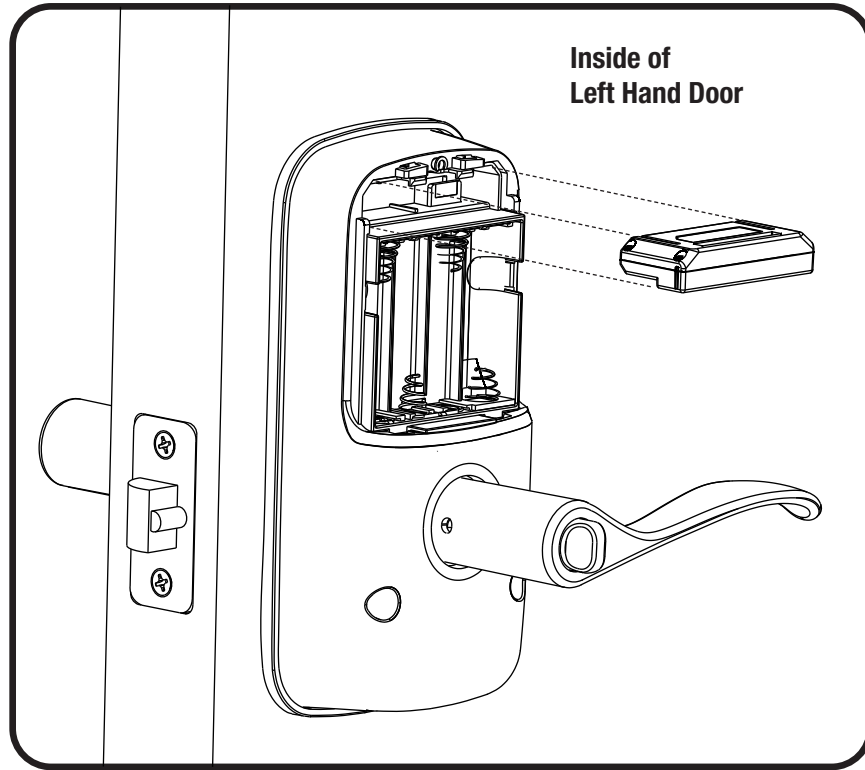

9

Installing Batteries & Cover

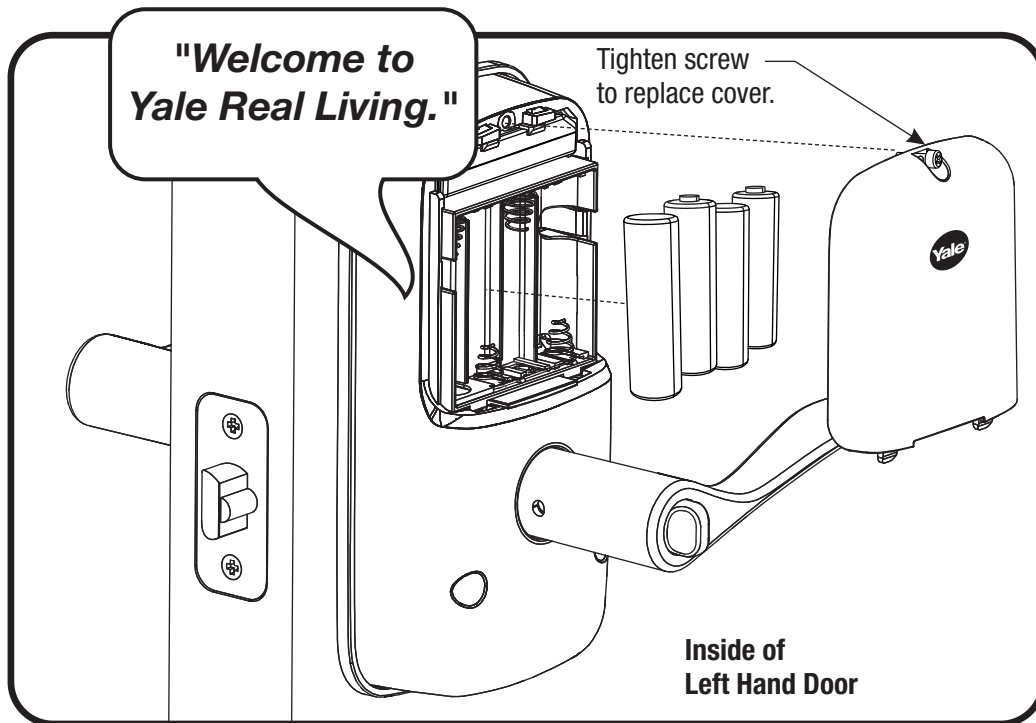

Congratulations, you've installed the Yale Real Living™ Touchscreen Lever!
Continue with Programming Instructions to customize your product.

Resetting Lock to Factory Default

When lock is reset to factory defaults all user codes (including the Master PIN code*) are deleted and all programming features are reset to original default settings (see below).

1. Remove the battery cover and batteries.
2. Remove the interior escutcheon to access the reset button.
3. The reset button (see image at right) is located above the PCB cable connector.
4. While pressing the reset button (minimum of 3 seconds) reinstall batteries. Release reset button.
5. Replace battery cover.

Upon reset, Master PIN Code creation is the only option available and must be performed prior to any other programming of the lock.

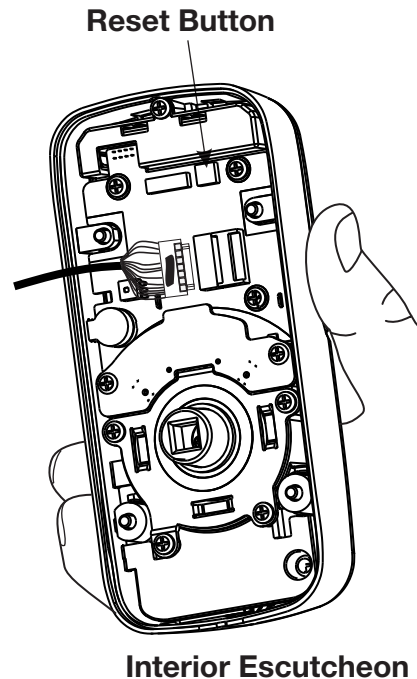

FCC:

Class B Equipment

This equipment has been tested and found to comply with the limits for a Class B digital device, pursuant to Part 15 of the FCC Rules. These limits are designed to provide reasonable protection against harmful interference in a residential installation. This equipment generates, uses, and can radiate radio frequency energy and, if not installed and used in accordance with the instructions, may cause harmful interference to radio communications. However, there is no guarantee that interference will not occur in a particular installation. If this equipment does cause harmful Interference to radio or television reception, which can be determined by turning the equipment off and on, the user is encouraged to try to correct the interference by one or more of the following measures:

- Reorient or relocate the receiving antenna.
- Increase the separation between the equipment and receiver.
- Connect the equipment into an outlet on a circuit different from that to which the receiver is connected.
- Consult the dealer or an experienced radio/TV technician for help.

Warning: Changes or modifications to this device, not expressly approved by **Yale Security Inc.** could void the user's authority to operate the equipment.

Industry Canada:

This Class A digital apparatus meets all requirements of the Canadian Interference Causing Equipment Regulations. Cet appareillage numérique de la classe A répond à toutes les exigences de l'interférence canadienne causant des règlements d'équipement.

Hardware Troubleshooting

Cycle lock in both the locked and unlocked positions. If problems are found:

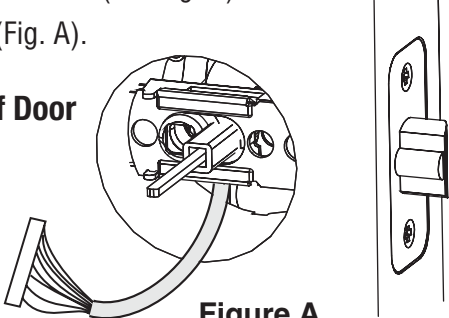
<p>Door is binding</p> <ol style="list-style-type: none">Check that door and frame are properly aligned and door is free swinging.Check hinges: They should not be loose or have excessive wear on knuckles.
<p>Latch will not deadlock</p> <ol style="list-style-type: none">Check for sufficient clearance of the latch within the strike-side jamb. Correct this by increasing the depth of the pocket for the latch.Check for misalignment of latch and/or strike which may be preventing latch from properly entering the strike. With the door open, extend and retract the latch; if it is smooth, check the strike alignment.
<p>Latch does not extend or retract smoothly</p> <ol style="list-style-type: none">Latch and strike are misaligned, see above.Check the backset of door relative to adjustments already made to latchVerify proper door preparation and re-bore holes that are too small or misaligned.Verify keypad wire harness is routed under the latch (see Fig. A).Verify latch is installed with correct side up (Fig. A). <div style="text-align: center;"><p>Interior of Door</p><p>Figure A</p></div>

Changing Lock: Replacing Cylinder

- To Remove cylinder:
See installation Step 6 "Installing Exterior Lever" and reverse appropriate actions to remove the exterior lever handle and cylinder.
- To install new cylinder:
 - Follow appropriate actions of installation Step 6 "Installing Exterior Lever" to replace the cylinder and exterior lever handle.
 - Test operation of new cylinder and key by following "Testing Operation".

Yale Locks & Hardware

Product Support Tel 800.810.WIRE (9473) • www.yalelocks.com

Yale Locks & Hardware is a division of Yale Security Inc., an ASSA ABLOY Group company.

Yale® is a registered trademark of Yale Security Inc., an ASSA ABLOY Group company.

Yale Real Living™ is a trademark of Yale Security Inc., an ASSA ABLOY Group company.

Copyright © 2014, Yale Security Inc., an ASSA ABLOY Group company.

All rights reserved. Reproduction in whole or in part without the express written permission of Yale Security Inc. is prohibited.

YALE, with its unique global reach and range of products, is the world's favorite lock
– the preferred solution for securing your home, family and personal belongings.

ASSA ABLOY is the global leader in door opening solutions,
dedicated to satisfying end-user needs for security, safety and convenience.

Programming Instructions

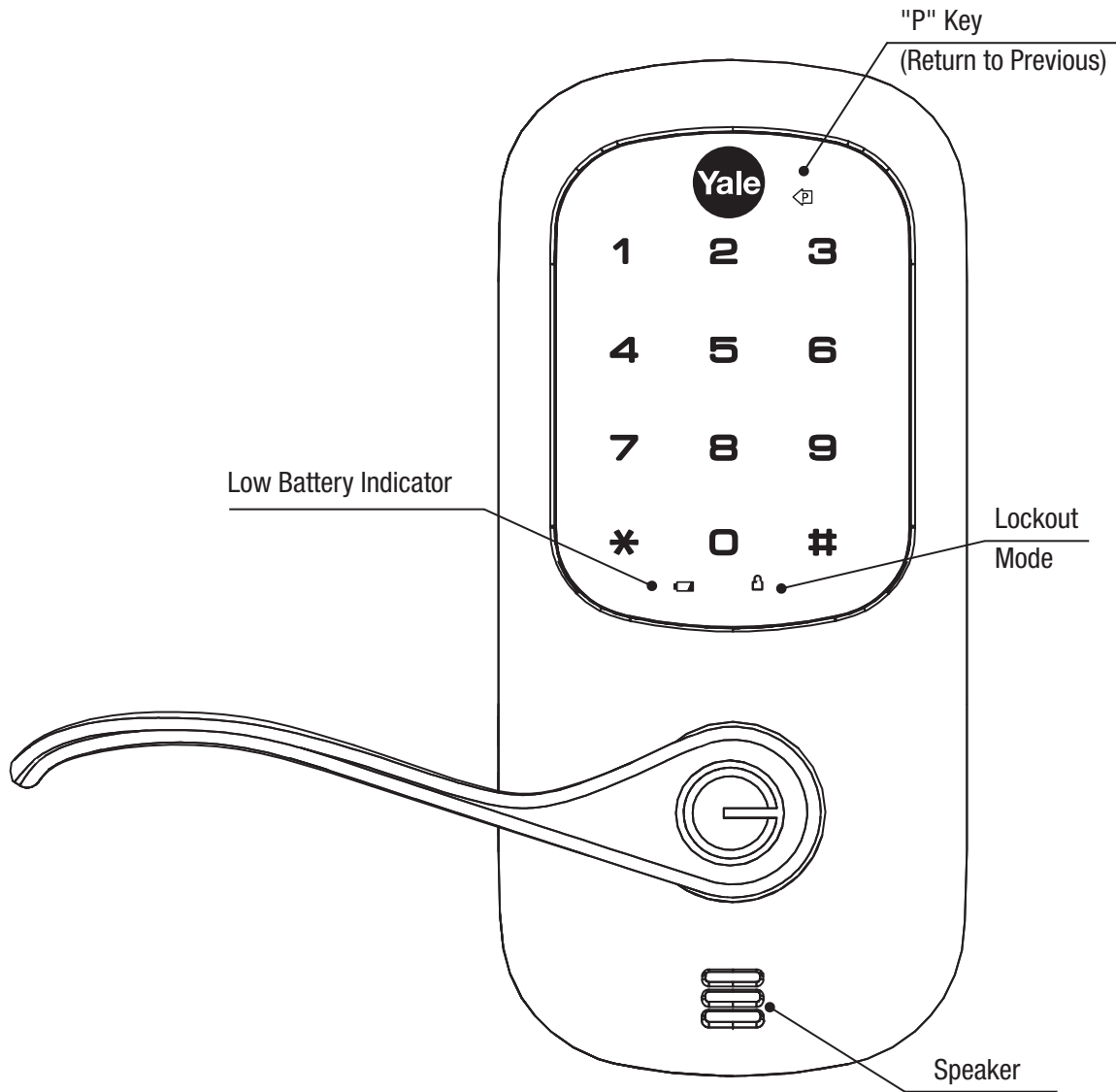

Creating a Master PIN Code must be performed upon installation or after resetting the lock to factory default. Programming and use of lock is not possible until this step has been successfully completed.

Max User Codes = 250 with Network Module. Max User Codes = 25 without.

Lock Activation

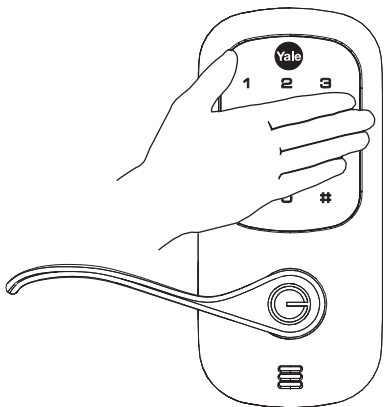

OR

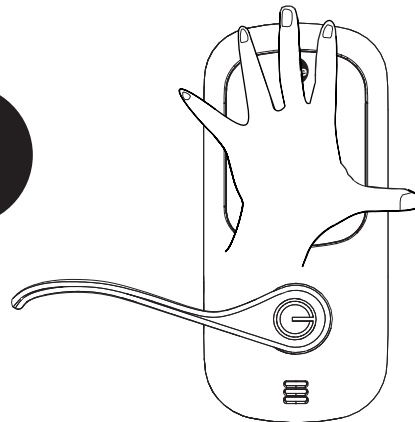

1

Creating Master PIN Code



Creating a Master PIN Code must be performed upon installation or after resetting the lock to factory default. Programming and use of lock is not possible until this step has been successfully completed.

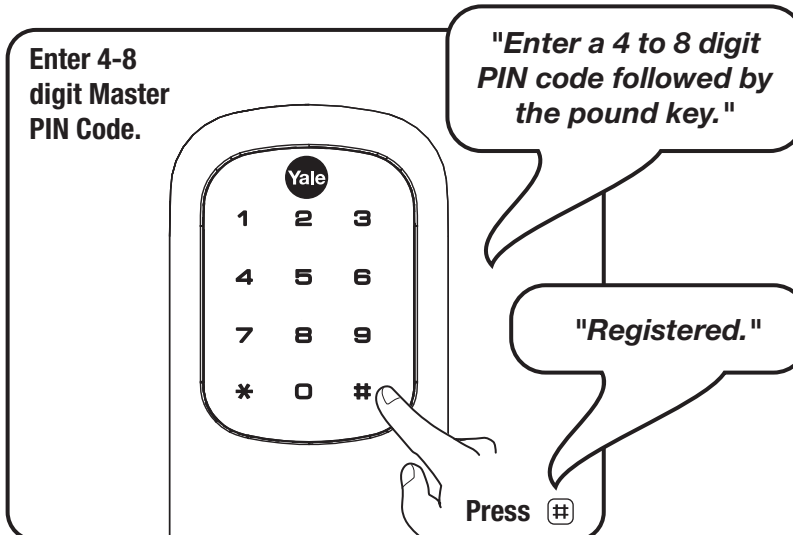
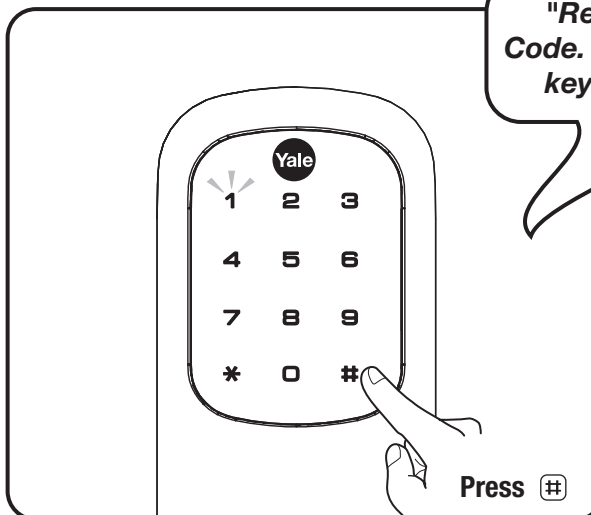
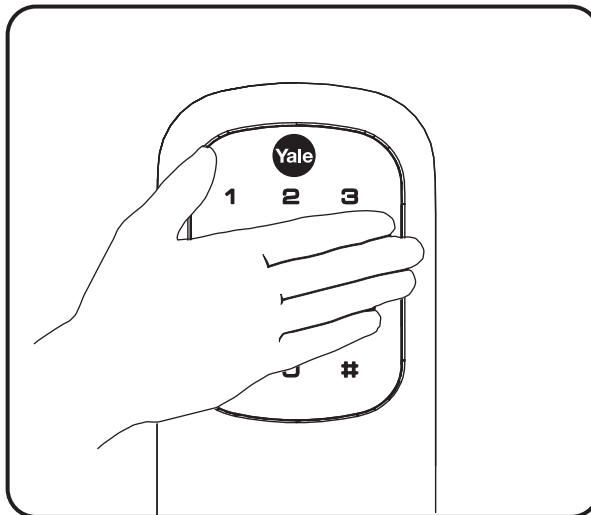

2

Creating User PIN Codes

Master PIN code must be created first.

*Max user codes = 250 with Network Module. Max user codes = 25 without.

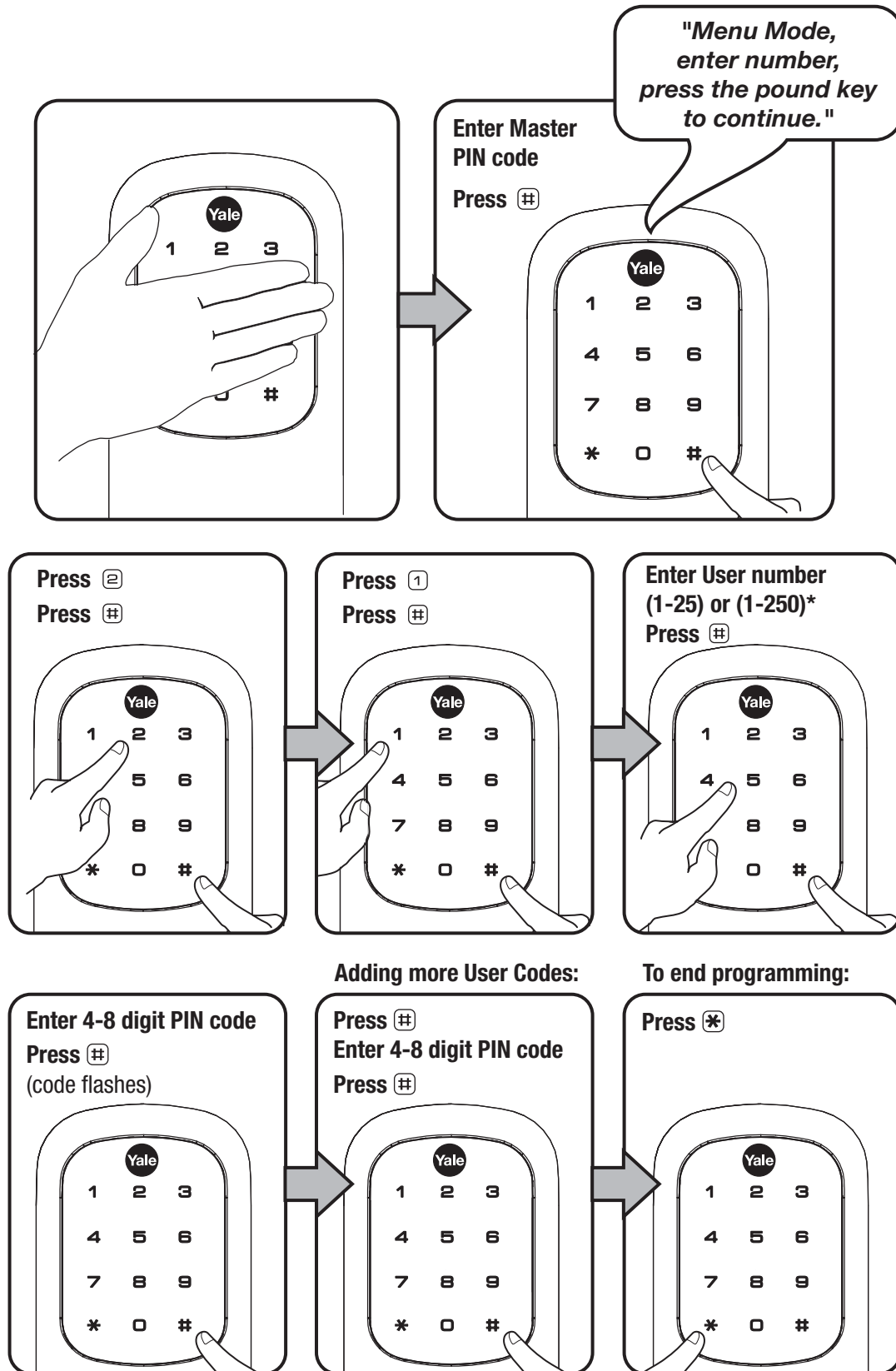

3

Unlocking Door with PIN Code

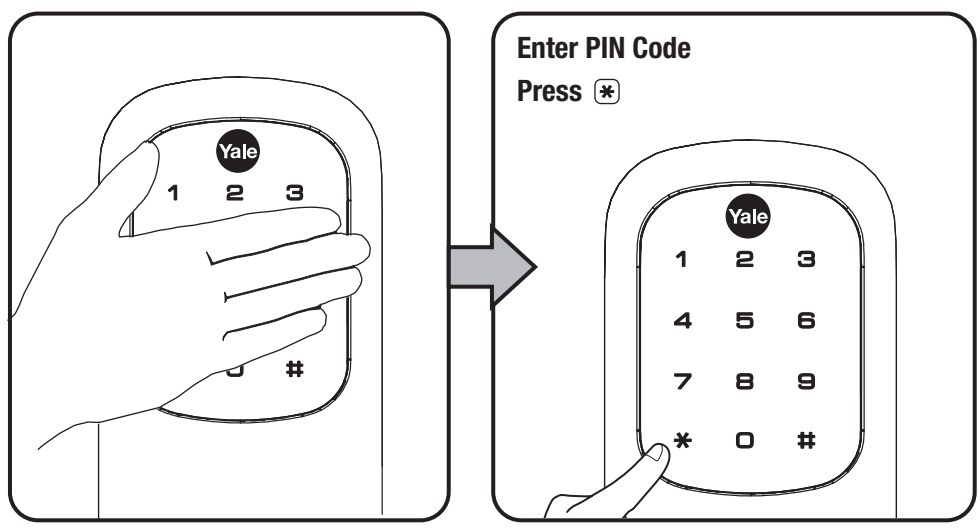

Code Chart Duplicate if necessary

PIN Code Management (With Network Module - Up to 250 Users)			
User Type	User Name	User #	PIN Code
Master			
User ____			
User ____			
User ____			

Factory Settings

Settings	Factory Setting
Master PIN Code	Registration required*
Automatic Re-lock	Disabled
Inside Indicator Light	Disabled (Off)
One Touch Locking	Enabled
Volume Setting	Enabled (Low)
Automatic Re-lock Time	30 Seconds
Wrong Code Entry Limit	5 Times
Shutdown Time	60 Seconds

*The Master PIN code must be registered prior to any other programming of the lock.

Definitions

All Code Lockout Mode: This feature is enabled by the Master code. When enabled, it restricts all user (except Master) PIN code access. When attempting to enter a code while the unit is in Lockout, the RED locked padlock will appear on the screen.

Automatic Re-lock Time: After a successful code entry and the unit unlocks, it will automatically re-lock after thirty (30) seconds.

Inside Indicator Light: Located on the interior escutcheon. Shows active status (Locked) of lock and can be enabled or disabled in the **Advanced Lock Settings** (Main Menu selection #3).

Language Setting Mode: Choosing English (1), Spanish (2) or French (3) becomes the (default) setting for the lock's voice prompts.

Low Battery: When battery power is low, the Low Battery Warning indicator flashes RED. If battery power is completely lost, use the cylinder key override.

Master PIN Code: The Master PIN code is used for programming and for feature settings. **It must be created prior to programming the lock.** The Master code will also operate (unlock/lock) the lock.

Network Module Setting: With the optional Network Module installed, this setting becomes available thru the Main Menu (7) and allows the lock to connect with a network controller.

One Touch Locking: When the latch is retracted, activating the keypad will extend the latch (during Automatic Re-lock duration or when Automatic Re-lock is disabled). When One-Touch Re-lock is **not** in use (**disabled**), any valid PIN code will re-lock the lock.

Previous: While in Menu Mode, pressing this icon cancels the current operation and returns the user to the previous step.

Shutdown Time: The unit will shutdown (flashing RED) for sixty (60) seconds and not allow operation after the wrong code entry limit (5 attempts) has been met.

Tamper Alert: Audible alarm sounds if attempting to forcibly remove outside lock from door.

User PIN Code: The User code operates the lock. Maximum number of user codes is 250 with Network Module; without Network Module, maximum is 25 users codes. Note: When deleting User PIN code(s), screen will display User Number (not PIN code) being deleted.

Volume Setting Mode: The volume setting for PIN code verification is set to **Low (2)** by default; otherwise it can be set to **High (1)** or **Silent (3)** for quiet areas.

Wrong Code Entry Limit: After five (5) unsuccessful attempts at entering a valid PIN code, the unit will shut down and not allow operation.

Feature Programming Through Menu Mode Using Master PIN code*

1. Touch screen with back of hand or palm to activate. 
2. Enter 4-8 digit master PIN code* followed by **#** key.
Lock Response: "Menu mode, enter number, press **#** key to continue."
3. Enter digit corresponding to the function to be performed followed by the **#** key.
Follow the voice commands.

*The Master PIN code must be registered prior to any other programming of the lock.

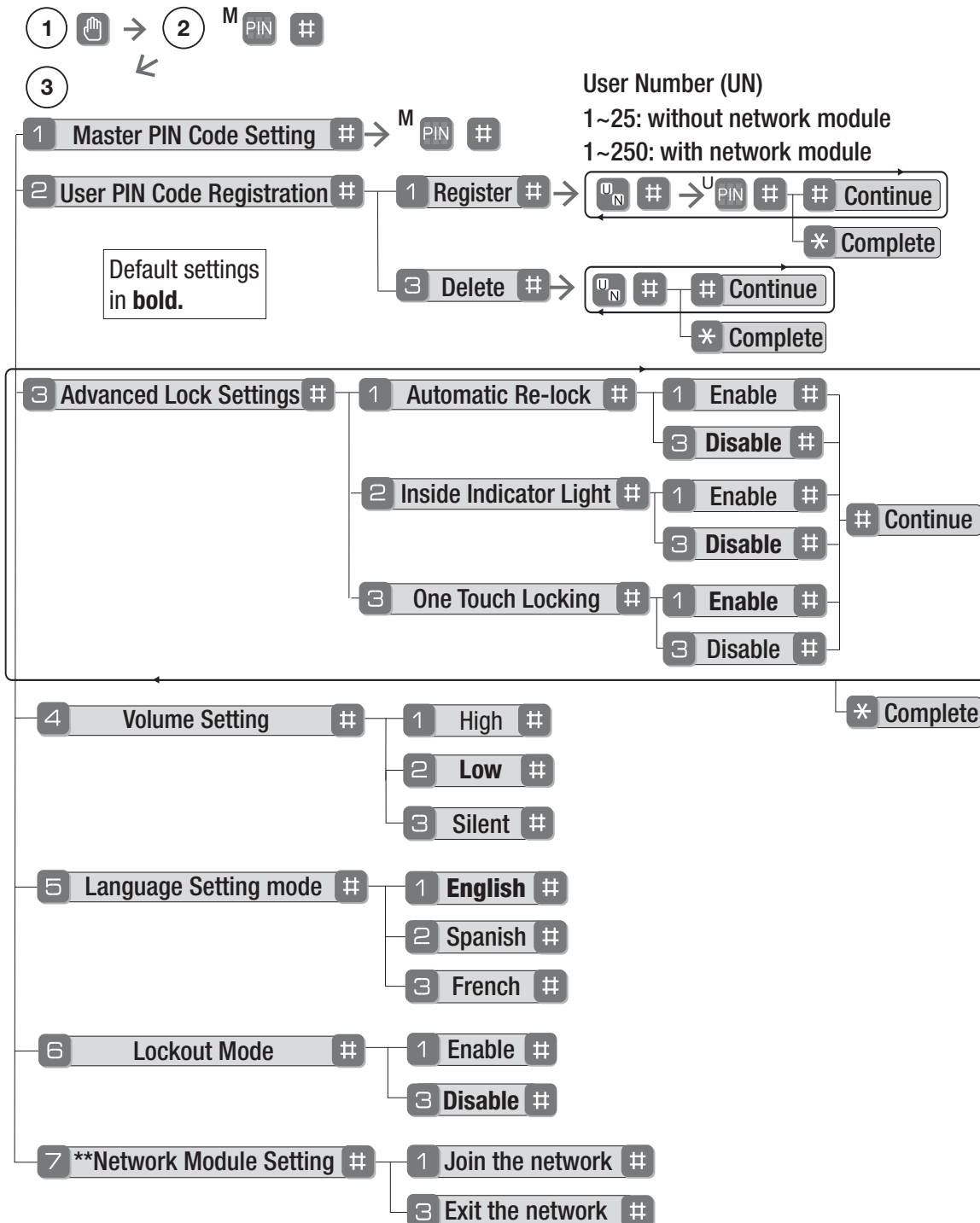

**This function appears only with RF network module installed.

Programming Troubleshooting

Symptom	Suggested Action
Lock does not respond – door is open and accessible.	<ul style="list-style-type: none"> • Touchscreen becomes active when pressed w/whole hand. Use a larger area of the hand or fingers and verify contact with at least 3 areas. • If touchscreen numbers are visible, check to see if they respond when pressed. • Check batteries are installed and oriented correctly (polarity) in the battery case. • Check batteries are in good condition; replace batteries* if discharged. • Check to see if touchscreen harness is fully connected and not pinched.
Lock does not respond – door is locked and inaccessible.	<ul style="list-style-type: none"> • Batteries may be completely discharged. • Use mechanical key to gain entry and replace batteries* .
Unit is on for a while then shows no reaction. Lights dim.	<ul style="list-style-type: none"> • Batteries do not have enough power. Replace batteries* .
Unit chimes to indicate code acceptance, but the door will not open.	<ul style="list-style-type: none"> • Check the door gaps for any foreign objects between door and frame. • Check that the wire harness is firmly connected to the PCB.
Unit operates to allow access, but will not automatically re-lock.	<ul style="list-style-type: none"> • Check to see if Auto Re-lock Mode is enabled. • Disable Auto Re-lock Mode to lock the door (automatically). • If low battery indicator is lit (see below), change batteries* .
PIN codes will not register.	<ul style="list-style-type: none"> • PIN codes must consist of 4 to 8 digits to register. • The same PIN code cannot be used for multiple users. • Registration/management of PIN codes is set by the authority of the Master Code. which is set first. • Contact the Master user. • User codes must be entered within 5 seconds (while touchscreen is active) or process will have to be restarted. • Star[*] or pound[#] cannot be used as part of the PIN code.
Upon entering a PIN code and pressing [*] key, the unit displays "invalid code" error or lock times out without responding.	<ul style="list-style-type: none"> • Lockout Mode is enabled. • Only the Master can enable/disable Lockout Mode. • Contact the Master user.
Upon entering a PIN code and pressing the [*] key, the red padlock icon appears and there are different tones.	<ul style="list-style-type: none"> • Check to see if the lock is set to Lockout Mode. • Setting/managing Lockout Mode is done through Master Code only. Contact the Master user.
The unit operates, but it makes no sound.	<ul style="list-style-type: none"> • Check to see if Silent Mode is enabled (see Feature #4).
The unit responds "Low Battery"	<ul style="list-style-type: none"> • This is the alert to replace the batteries. Replace all four (4) batteries* with new AA Alkaline batteries.
Upon entering a PIN code and pressing the [*] key, the unit responds "Wrong number of digits".	<ul style="list-style-type: none"> • The digits entered were incorrect or incomplete. Re-enter the correct code followed by the star[*] key.

* When batteries are replaced, Network Module locks have a real time clock that will be set through the User Interface (UI); it is recommended to verify correct date and time particularly those locks operating under Daylight Saving Time (DST).

** Network Module locks only